

MODERN  FLAMES



AUSTRALIA
ELECTRIC FIREPLACE
2020 PRODUCT CATALOG

MODERN FLAMES



ABOUT US

Modern Flames was established in 2008 and has quickly become the innovative leader in contemporary electric fireplace design and technology. After pioneering the linear electric fireplace throughout North America, Modern Flames' brand has skyrocketed with many firsts to market which include; the first linear recessed electric fireplace, the first fully built-in electric fireplace, the first outdoor electric and now the first steam electric fireplace. Modern Flames' products have gained notoriety with architects, designers, builders and homeowners for its unbelievable life-like flame appearance,

ease of installation and affordable cost to the builder compared to wood and gas. With global movement into greener building and high efficiency products, Modern Flames' new FusionFire™ technology allows consumers to achieve the look of a fireplace without sacrificing the realism of a real fire. With a new corporate headquarters and expanded warehouse in Phoenix, Arizona, along with its new steam technology, Modern Flames continues to be a leader in the electric fireplace industry. Modern Flames is innovating the industry standards of tomorrow.



CONTENTS

4-7 Landscape Pro Multi Series

The Most Versatile Electric Fireplace

8-11 Landscape Pro Slim Series

Electric Fireplace with Unique Frameless Design

12-15 Landscape FullView 2 Series

Built-in Clean Face Electric Fireplace

16-19 Ambiance CLX2 Series

Framed Recessed Wall Mount Electric Fireplace

20-23 Spectrum Series

Built-in Flush Mount Electric Fireplace

24-25 ZCR2 Series

Electric Fireplace Insert

26-27 Sunset Charred Oak Log Set

Electric Log Set



Landscape Pro Multi 56"

 Hybrid-FX™
FLAME TECHNOLOGY

LANDSCAPE PRO MULTI

The Most Versatile Electric Fireplace on the Market

- MULTI SIZES: **44" - 56" - 68" - 80"**
- MULTI INSTALL DEPTHS: BUILT-IN CLEAN FACE - PARTIAL 2x4 RECESS - WALL MOUNT
- MULTI CONFIGURATIONS: SINGLE SIDED, LEFT CORNER, RIGHT CORNER & 3-SIDED (BAY)
- MULTI LIGHT CONTROL: FLAME COLOR, EMBER BED COLOR & DOWNLIGHTING COLOR
- MULTI LIGHT COLORS: FULL RGB COLOR SPECTRUM IN ALL LIGHTING FEATURES

Up to 12 different install configurations included standard in the box!

Choose a beautiful single sided installation or get creative and design the fireplace exactly how you want into the feature wall of your dreams.



New high intensity multi-color flame technology paired with matching up lighting and downlighting create the full customizable experience in the home.

Hundreds of different stunning color combinations to select from!

STANDARD FEATURES

LIGHTING

- ✓ New Hybrid-FX™ Flame Technology
- ✓ Random, Beautiful Flame Image
- ✓ High Intensity RGB Flame Colors
- ✓ RGB Ember Bed Colors
- ✓ RGB Downlighting Colors
- ✓ Individually Contoled or Synchronized
- ✓ Full Color Spectrum in Each Light Feature
- ✓ Active Ember Bed

MEDIA

- ✓ Clear Acrylic Stone Media
- ✓ Black Smoke Acrylic Crystals
- ✓ Hand-Painted Canyon Driftwood Log Set – Highly Detailed Realism

HEAT

- ✓ Up To 5,000 BTU Heat Output
- ✓ Whisper Quiet Fan
- ✓ High Efficiency PTC Ceramic Heater

CONTROLS & FUNCTIONS

- ✓ Basic Features Manual Controls
- ✓ Full Feature Remote Control
 - RGB Color Wheel
 - Brightness Slide Bar
- ✓ Full Feature Modern Flames App

OPTIONAL CONTROL

- ✓ Wireless Thermostat & Full Wall Control

LIGHTING - INDEPENDENT COLOR CONTROL

FULL COLOR SPECTRUM FLAME, EMBER BED & DOWNLIGHTING



MEDIA - PREMIUM LOG SET STANDARD

CANYON DRIFTWOOD LOG SET, SMOKE GLACIER CRYSTALS & CLEAR STONES



HEAT - 5,000 BTU

240V HIGH EFFICIENCY CERAMIC HEATER



FLAMES & LIGHTING
15 WATTS
NO HEAT



1500 WATT HEATER
240V 5,000 BTU
UP TO 40 SQM

MODERN FLAMES

Landscape Pro Multi Fireplaces are equipped with adjustable heaters controlled by remote or phone app. Wall tether has thermostat controls.

STANDARD CONTROLS

REMOTE CONTROL & MANUAL CONTROL



MODERN FLAMES

FULL FEATURED
WiFi APP



UPGRADE CONTROL

WIRELESS WALL TETHER WITH
THERMOSTAT CONTROL

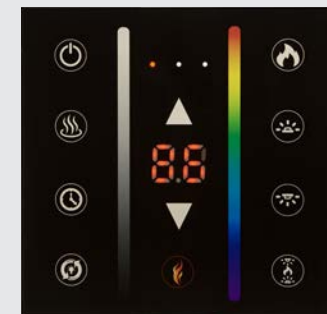

MULTI INSTALLATIONS - UP TO 12 DIFFERENT CONFIGURATIONS

- BUILT-IN/ CLEAN FACE INSTALLATION
- PARTIAL RECESS INSTALLATION (2x4 WALL)
- FLOATING WALL CABINET
- FLOOR CABINET
- SINGLE SIDED
- LEFT CORNER
- RIGHT CORNER

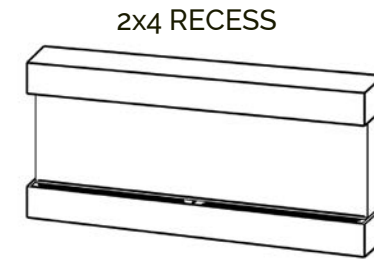
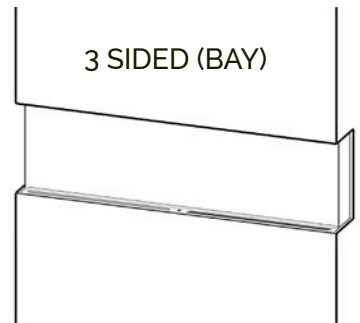
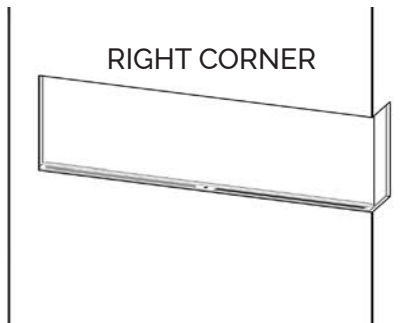
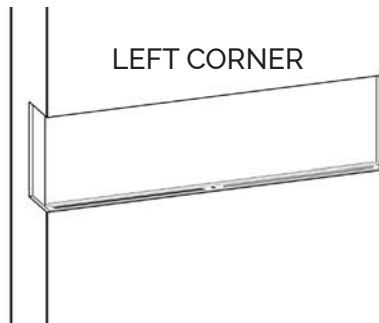

LANDSCAPE PRO MULTI DIMENSIONS (SEE DRAWINGS AT RIGHT)

MODEL & CONFIGURATION		VIEWING AREA			FIREBOX DIMENSIONS					
MODEL #	CONFIGURATION	A FRONT GLASS WIDTH	B SIDE GLASS WIDTH	C GLASS HEIGHT	D OVERALL WIDTH	E OVERALL HEIGHT	F OVERALL DEPTH	G BOTTOM TO VIEWING	H TOP TO VIEWING	I BACK TO VIEWING
LPM-4416	SINGLE SIDED	1115	-	394	1118	632	292	115	115	-
	CORNER (L/R)	1115	127	394	1118	632	292	115	115	105
	3-SIDED (BAY)	1115	127	394	1118	632	292	115	115	105
LPM-5616	SINGLE SIDED	1420	-	394	1423	632	292	115	115	-
	CORNER (L/R)	1420	127	394	1423	632	292	115	115	105
	3-SIDED (BAY)	1420	127	394	1423	632	292	115	115	105
LPM-6816	SINGLE SIDED	1725	-	394	1728	632	292	115	115	-
	CORNER (L/R)	1725	127	394	1728	632	292	115	115	105
	3-SIDED (BAY)	1725	127	394	1728	632	292	115	115	105
LPM-8016	SINGLE SIDED	2029	-	394	2032	632	292	115	115	-
	CORNER (L/R)	2029	127	394	2032	632	292	115	115	105
	3-SIDED (BAY)	2029	127	394	2032	632	292	115	115	105

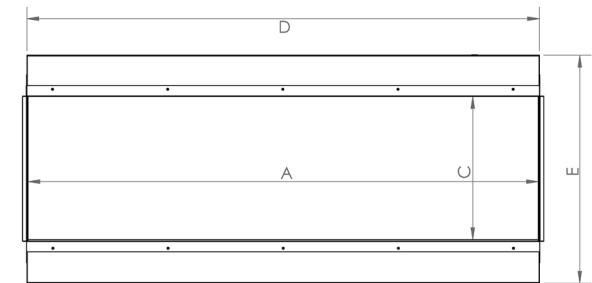

FRONT VIEW

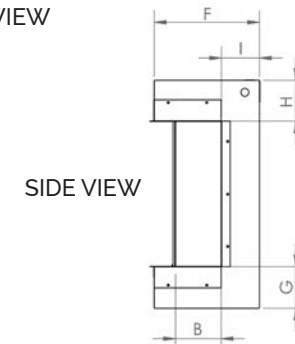

SIDE VIEW

The logo features a stylized white flame icon to the left of the text "Hybrid-FX™" in a bold, sans-serif font, with "FLAME TECHNOLOGY" in a smaller font below it.

Hybrid-FX™
FLAME TECHNOLOGY

Landscape Pro Slim 56"













LANDSCAPE PRO SLIM SERIES

Electric Fireplace with Unique Frameless Design

The Landscape Pro Slim electric fireplace is the perfect option for any customer looking for a unique frameless look installed into a 2" x 6" wall. This new Slim model in the Landscape Pro Series features independently controlled flame plus up & down lighting with an edge-to-edge viewing area. This Pro Series model features NEW Hybrid-FX™ flame technology, high intensity LED lighting and active ember bed, Driftwood Logs & Wi-Fi controls all as standard features. The Landscape Pro Slim features a 5000 BTU heater, remote and wireless control and comes in 2 linear sizes, 44" & 56".



STANDARD FEATURES

-  12 Different Flame & Ember Bed Color Options
-  Back Flame & Ember Bed Controlled Independently or Together
-  New Hybrid-FX™ Flame Technology
-  Driftwood Log Set
-  Full Flame Viewing Area
-  Fully Finished Clean Face Installation
-  Finish Trim Kit Included
-  High Efficiency Ceramic Heater
-  Whisper Quite Fan
-  Variable Flames
-  Remote Control
-  Wi-Fi Controls with Modern Flames App

LANDSCAPE PRO SLIM SERIES

Driftwood Logs & Acrylic Ember Bed Included Standard



Available in 2 Standard Widths with Driftwood Log Set & Acrylic Ember Bed:

44"

56"



Flame & Ember Bed Colors - Many Color Combinations Available and Controlled Independently



Comes Standard with 2 Types of Acrylic Media: Smoke & Clear

10



Landscape Pro Slim 56"

LANDSCAPE PRO SLIM

Dimension Specs

LANDSCAPE PRO SLIM DIMENSIONAL SPECS

MODEL #	A	B	C	D	E	FRAMING (WxHxD)
LPS-4412/INT	345	1118	153	607	1131	1143 W x 616 H x 140 D
LPS-5612/INT	345	1423	153	607	1436	1448 W x 616 H x 140 D

LANDSCAPE PRO SLIM 56" DIMENSIONAL DRAWING SHOWN

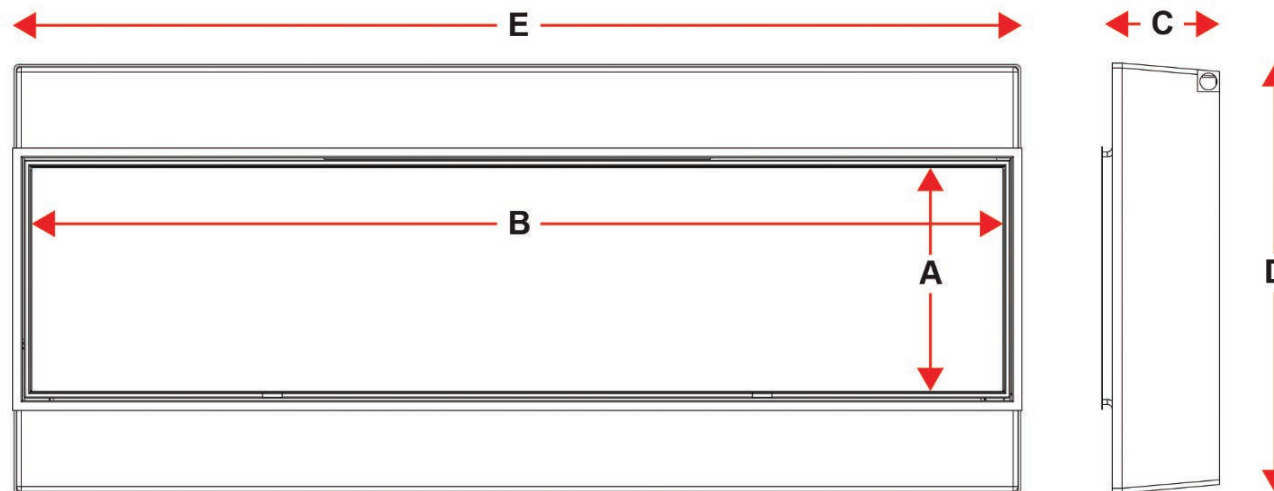

STANDARD CONTROLS REMOTE CONTROL & MANUAL CONTROL



MODERN FLAMES

FULL FEATURED
WiFi APP



UPGRADE CONTROL

WIRELESS WALL TETHER WITH
THERMOSTAT CONTROL

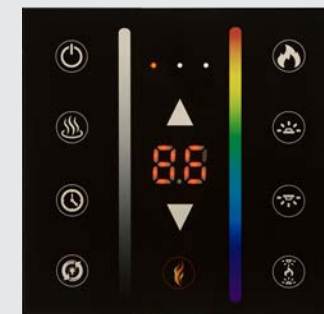

LFV2-2000/400-AU













LANDSCAPE FULLVIEW 2 SERIES

Built-in Clean Face Electric Fireplace

The Landscape FullView 2 built-in electric fireplace is the first of its kind creating a perfect substitute for a linear gas fireplace. This unique frameless design allows for edge to edge flame presentation as well as unlimited surround capabilities. Available in 5 different lengths for any application as well as 3 customizable flame bed options for different fit and finishes. An optional 2 stage heater is also included for supplemental heat up to 45 square meters.



STANDARD FEATURES

-  Realistic Natural Flame Appearance
-  Orange/Blue Color Changing Flame
-  Glowing Coal Ember Bed
-  5,000 BTU Heater
-  Full Flame Viewing Area
-  Fully Finished Clean Face Installation
-  Affordable Alternative to Gas
-  Can be Installed Beneath a TV
-  Cool to the Touch with Heat On or Off
-  Remote Control
-  Wall Tether Touch Screen Control

LANDSCAPE FULLVIEW 2 SERIES

Available in 5 Linear Widths with Orange or Blue Changeable Flames



Fireplace Height 400 with 5 Widths Available: 1000 1500 2000 2500 3000



Blue Flames shown with Standard Media – Standard & Dusted w/paint



Orange Flames shown with Standard Media – Standard & Dusted w/paint

MEDIA UPGRADES



LFV2-1000/400-AU with DWLS2-1000



LFV2-2500/400-AU

LANDSCAPE FULLVIEW 2 SERIES

Technical Specs



NEW REMOTE CONTROL

Separate controls for on/off, variable heat and variable flame.



TOUCH SCREEN TECHNOLOGY

Touch control panel can be wall mounted within ten feet of the fireplace. The 3 stacked icons (in order) operate the power, heat (on/off) and light intensity. Hold the light intensity for five seconds to change the flame color from orange to blue. All touch controls fade to black after 4 seconds.

LFV2 TECHNICAL SPECS

MODEL #	VOLTS	WATTS	BTU's	FRAMING (ROUGH OPENING)	INSTALLATION TYPE
LFV2-1000/400-AU	AC 240V / 50Hz	1,530	5000	1420 L x 305 D x 585 H	Built-In Clean Face
LFV2-1500/400-AU	AC 240V / 50Hz	1,530	5000	1925 L x 305 D x 585 H	Built-In Clean Face
LFV2-2000/400-AU	AC 240V / 50Hz	1,550	5000	2435 L x 305 D x 585 H	Built-In Clean Face
LFV2-2500/400-AU	AC 240V / 50Hz	1,600	5000	2940 L x 305 D x 585 H	Built-In Clean Face
LFV2-3000/400-AU	AC 240V / 50Hz	1,600	5000	3450 L x 305 D x 585 H	Built-In Clean Face

LFV2-1500/400-AU DIMENSIONAL DRAWING SHOWN

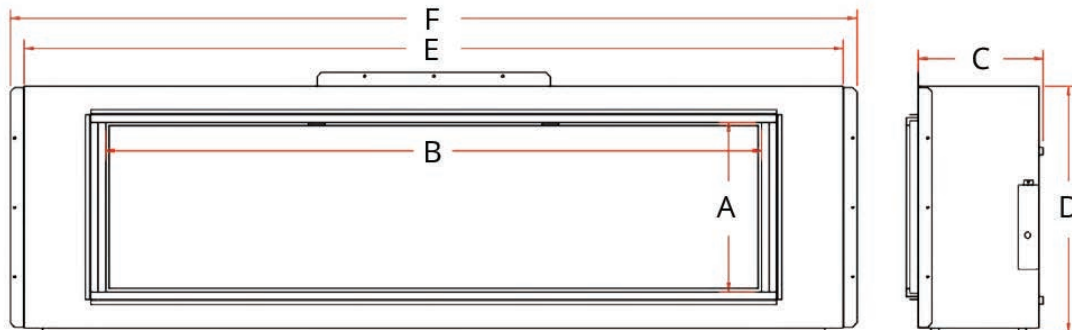

LFV2 DIMENSIONAL SPECS (SEE DRAWING AT LEFT)

MODEL #	A	B	C	D	E	F
LFV2-1000/400-AU	385	1000	295	572	1420	1455
LFV2-1500/400-AU	385	1500	295	572	1925	1963
LFV2-2000/400-AU	385	2000	295	572	2435	2471
LFV2-2500/400-AU	385	2500	295	572	2940	2879
LFV2-3000/400-AU	385	3000	295	572	3450	3487



AL1500CLX2-G





AMBIANCE CLX2 SERIES

Recessed or Wall Mount Electric Fireplace

The popular Ambiance CLX2 electric fireplace offers the ultimate combination of versatility and design. This award winning, upgraded product series has an improved look offering simple customization. The Ambiance CLX2 features a NEW color changing orange to blue flame for year-round use, a thermostat for setting that ideal temperature and includes 2 styles of media for 2 distinctive looks: coals and glacier diamond glass.



STANDARD FEATURES

-  Recessed or Wall Mount Installation
-  Color Changing Orange to Blue Flame
-  Media – Coals & Glacier Glass (Included)
-  Low Energy LED Flame Technology
-  Unsurpassed Realistic Flame Pattern
-  Hi-tech Touch Screen Controls
-  New Sleek Remote
-  Can be Installed Beneath a TV
-  Variable Heat with Thermostat
-  Variable Flame Controls
-  240V Direct Plug-in
-  Do it Yourself Installation Instructions

AMBIANCE CLX2 SERIES

4 Linear Widths with More Ways to Customize



Fireplace Height 650 with 4 Widths Available:

1150

1500

2000

2500

STANDARD FEATURES INCLUDED: COAL & GLACIER GLASS EMBER BEDS



Orange Flames with Standard Coal Bed



Orange Flames with Standard Glacier Glass Ember Bed

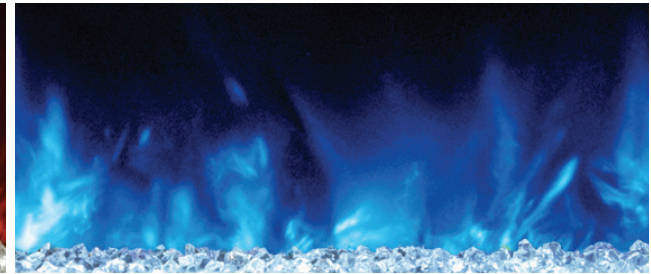

Blue Flames with Standard Glacier Glass Ember Bed



AMBIANCE CLX2 SERIES

Technical Specs

CLX2 TECHNICAL SPECS

MODEL#	VOLTS	WATTS	BTU's	FRAMING (FINISHED OPENING)	INSTALLATION TYPE
AL1150CLX2-G	AC 220V / 50Hz	1,520	5,000	762 L x 496 H x 102 D	Recessed / Wall Mount
AL1500CLX2-G	AC 220V / 50Hz	1,530	5,000	1143 L x 496 H x 102 D	Recessed / Wall Mount
AL2000CLX2-G	AC 220V / 50Hz	1,550	5,000	1651 L x 496 H x 102 D	Recessed / Wall Mount
AL2500CLX2-G	AC 220V / 50Hz	1,570	5,000	2159 L x 496 H x 102 D	Recessed / Wall Mount

CLX2 DIMENSIONAL SPECS (SEE DRAWING BELOW)

MODEL #	A	B	C	D	E	F	G
AL1150CLX2-G	254	686	131	743	489	1150	648
AL1500CLX2-G	254	1067	131	1124	489	1500	648
AL2000CLX2-G	254	1575	131	1632	489	2000	648
AL2500CLX2-G	254	2083	131	2140	489	2500	648

AL1500CLX2 DIMENSIONAL DRAWING SHOWN

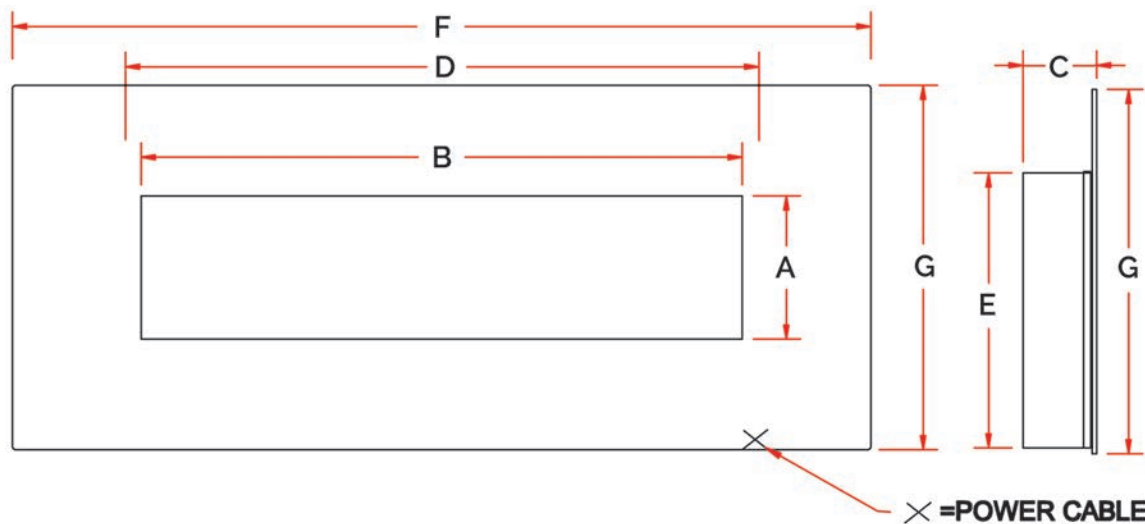

NEW REMOTE CONTROL
Separate controls for on/off, variable heat and variable flame.



TOUCH SCREEN TECHNOLOGY
A user-friendly series of touch controls operate power, heat (on/off) and light intensity. All touch controls fade to black after 4 sec.













SPECTRUM SERIES

Electric Fireplace Built-in Flush Mount

Modern Flames Spectrum Series Built-In Flush Mount Electric Fireplace brings the flame versatility and size options to the conventional electric fireplace. Our award winning flame appearance now features 12 different flame color combinations to choose from. A gray back screen allows the colors to shimmer and shine, dancing off multicolor glacier diamond glass, creating a crisp, clean flame and contemporary look. The Spectrum Series is available in 2 different size models which include a 50" & 74" Linear. A thermostat, touch control and remote completes this innovative series.



STANDARD FEATURES

-  Unsurpassed Realistic Flame Pattern
-  12 Color Flame Combinations
-  Glacier Glass Ember Bed
-  Low Energy LED Flame Technology
-  Touch Button Controls
-  New Sleek Remote
-  Can be Installed Beneath a TV
-  Variable Heat with Thermostat
-  Variable Flame Controls
-  240V Direct Plug-in
-  Do it Yourself Installation Instructions

SPECTRUM SERIES

12 Flame Color Combinations at the Push of a Button

The 6 button control panel is located at the top right of fireplace including the digital readout thermostat. Button #1 turns the fireplace on or off. Button #2 turns on the heater. Button #3 turns the heater temperature up and #4 turns the heat down. Button #5 cycles through the 12 different flame color combinations, and button #6 adjusts the flame intensity.



Blue



Cyan

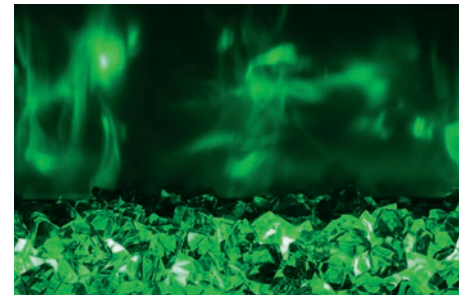

Emerald

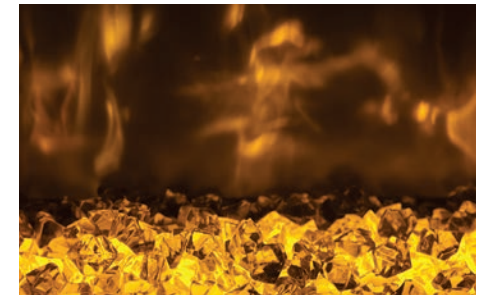

Gold

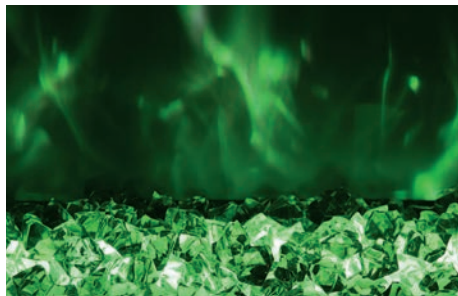

Green

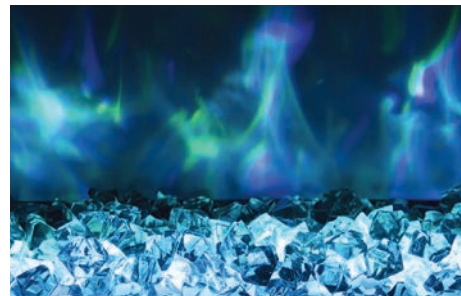

Ice Blue



Magenta



Multi



Orange

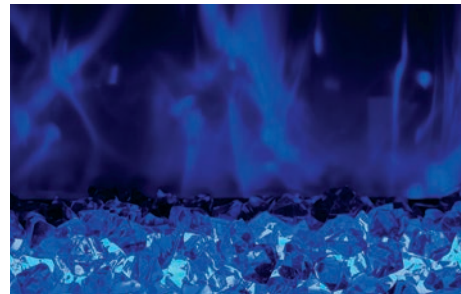

Purple



Red



White

SPECTRUM SERIES

Technical Specs



REMOTE CONTROL
 Separate controls
 for on/off
 variable heat
 and variable flame.

SPECTRUM TECHNICAL SPECS

MODEL #	VOLTS	WATTS	BTU's	FRAMING (FINISHED OPENING)	INSTALLATION TYPE
SL50-B	AC 240V / 50Hz	1,530	5,000	1263 L x 463 H x 203 D	Fully Recessed
SL74-B	AC 240V / 50Hz	1,530	5,000	1841 L x 463 H x 203 D	Fully Recessed

SPECTRUM DIMENSIONAL SPECS (SEE DRAWING BELOW)

MODEL #	A	B	C	D	E	F	G
SL50-B	336	1175	193	1216	457	1263	482
SL74-B	336	1791	193	1832	457	1879	482

SL50-B DIMENSIONAL DRAWING SHOWN

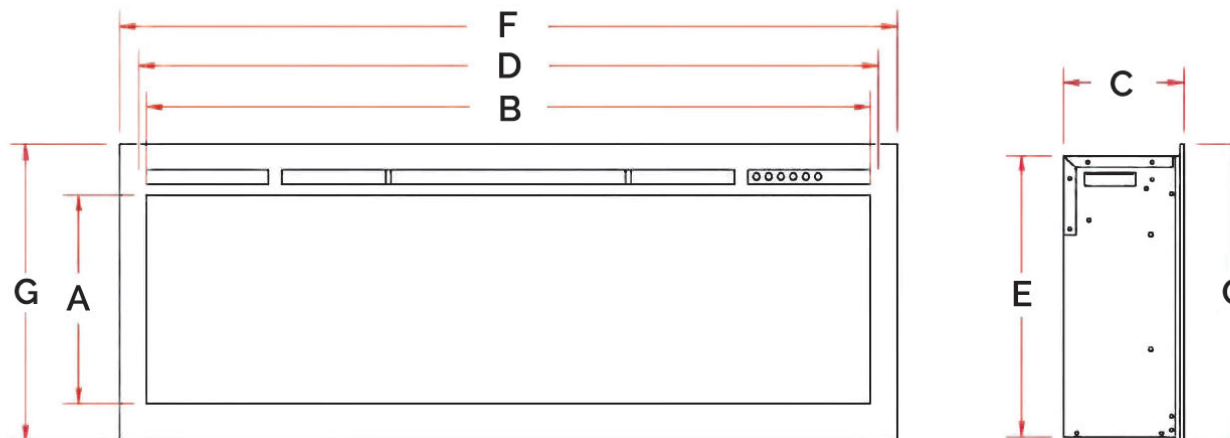



ZCR2-29C

ZCR2 INSERT

Electric Fireplace Insert

The ZCR2 Series is specifically designed to insert into an existing 762-914mm wood burning fireplace and provide a beautiful and economical substitute to a gas log set or gas insert. Simply run power to your fireplace & insert the ZCR2 into the firebox without the need of screws or attaching hardware. The ZCR2 comes standard with new canyon driftwood logs & contemporary glacier glass for a traditional or contemporary look. A standard 4800 BTU heater & touch screen controls with remote are all included. Finish off the ZCR2 with an optional trim kit to fit most firebox openings.

OPTIONAL TRIM KIT

ZCR2-29C with TK-ZCR2-3824
Covers most 914 mm wide Zero Clearance Fireplaces



Bottom 114 mm riser included with trim kit. Not required for install.

Trim Kit: TK-ZCR2-3824









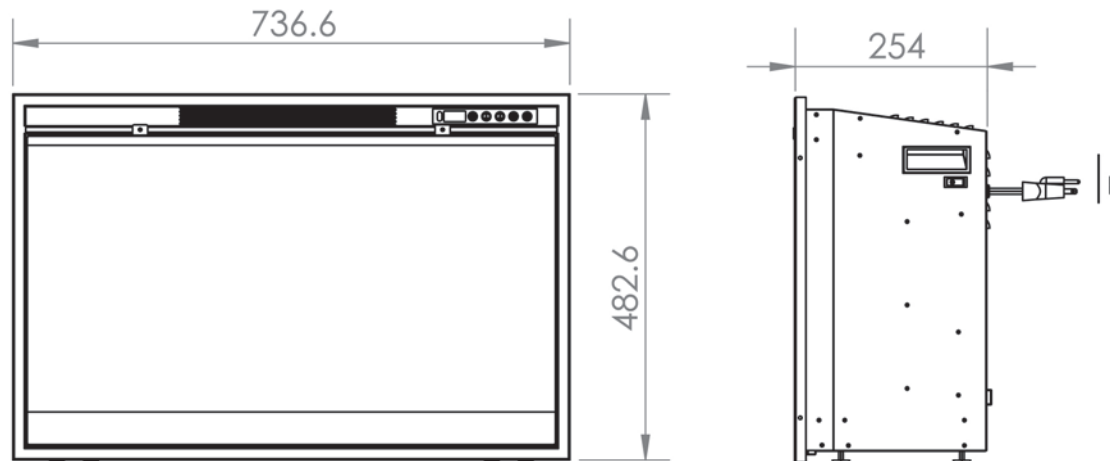

REMOTE CONTROL

Separate controls for on/off variable heat and variable flame.

ZCR2 DIMENSIONAL DRAWINGS



STANDARD FEATURES

-  Realistic Flame Appearance
-  Easy Access Push Button controls
-  1400 Watt /4800 BTU Heater
-  Fits into Existing Zero Clearance Fireboxes
-  Glowing LED Canyon Juniper Log Set
-  3 Stage Flame Brightness
-  Can be Installed Beneath a TV
-  Remote Control
-  240V Direct Plug-in



SCO-26

SUNSET CHARRED OAK LOGS

Electric Log Set

The Sunset Charred Oak Electric Logs set is the industries first battery powered and Wi-Fi enabled electric logs. This electric log set is designed to simply be unpackaged and installed into any existing wood burning fireplace without the hassle of running a electrical line. The Sunset Charred Oak features High Definition resin log detail, unsurpassed bark detail, 8 color paint scheme, Realistic LED ember bed, 6 stage lighting intensity and flame settings, hidden manual controls & Wi-Fi capability. Never has it been easier to add a full featured electric log set to your wood burning fireplace.











HIGH DEFINITION RESIN LOG & BARK DETAIL



OPTIONAL BATTER PACK & CHARGER (10 hours of use)



STANDARD FEATURES

-  High Definition Resin Log Detail
-  8 Color Log Paint Scheme
-  Realistic LED Ember Bed
-  6 Stage Lighting Intensity
-  Natural Flame Pattern
-  Hidden Manual Controls
-  Optional Lithium Ion Battery Pack
-  Wi-Fi Capability

SCO-20 LOG SET DIMENSIONS:

254 Height
495 Width
254 Depth

SCO-26 LOG SET DIMENSIONS:

311 Height
647 Width
343 Depth

MODERN FLAMES

Modern Flames Australia

Exim International (Australia) Pty LTD
24 Newheath Drive
Arundel, QLD 4214

Phone: 07-5630 6837

Toll Free: 1300 361557

Email: Info@ModernFlames.com



INNOVATING THE INDUSTRY STANDARDS OF TOMORROW